

# A Detector Scenario for the Muon-Collider Cooling Experiment

[Princeton/ $\mu\mu$ /97-8, <http://www.hep.princeton.edu/mumu>]

C. Lu, K.T. McDonald and E.J. Prebys

*Princeton U.*

July 28, 1997

**Goal:** Measure the emittance of the muon beam to 3% accuracy before and after the muon cooling apparatus.

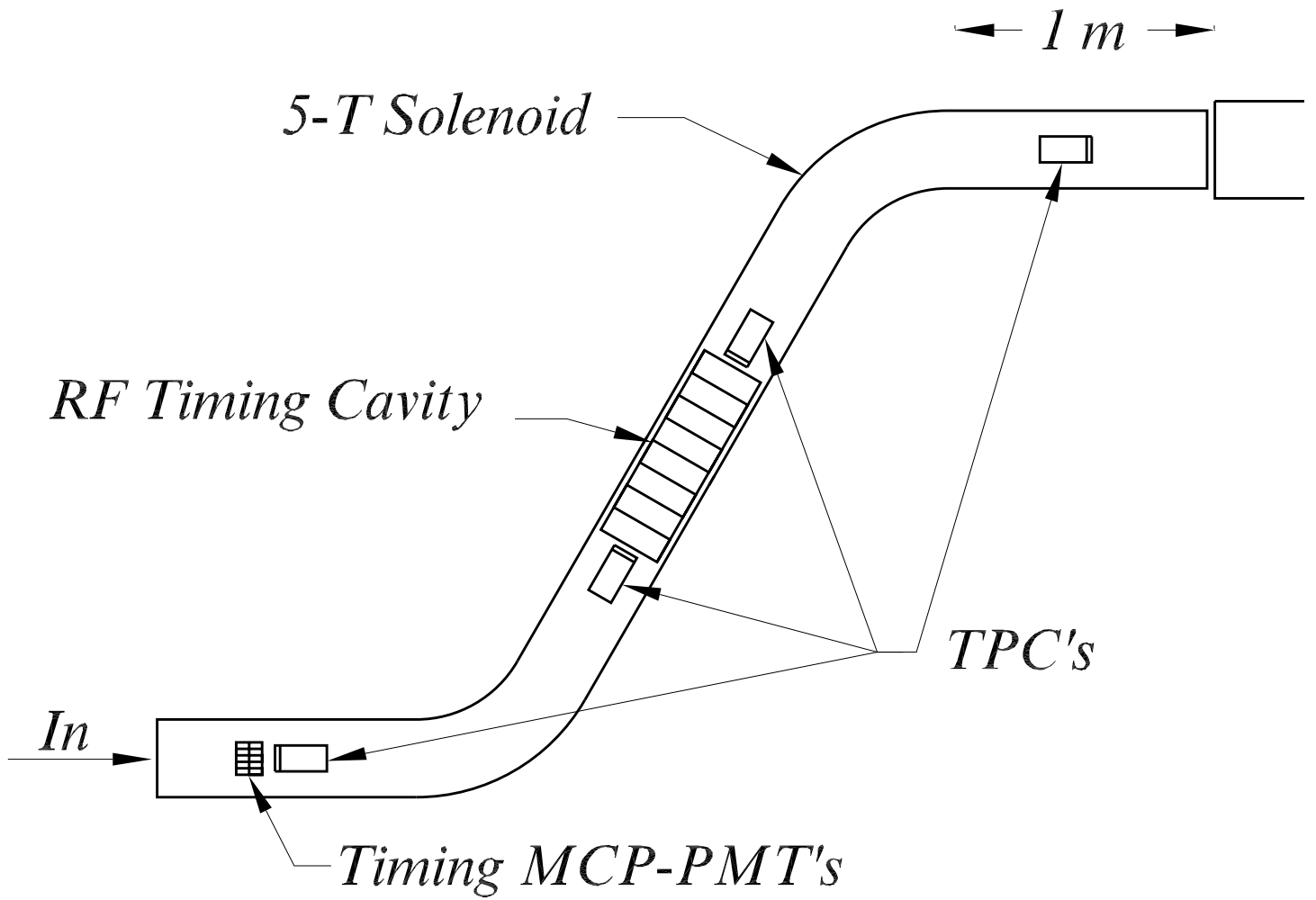
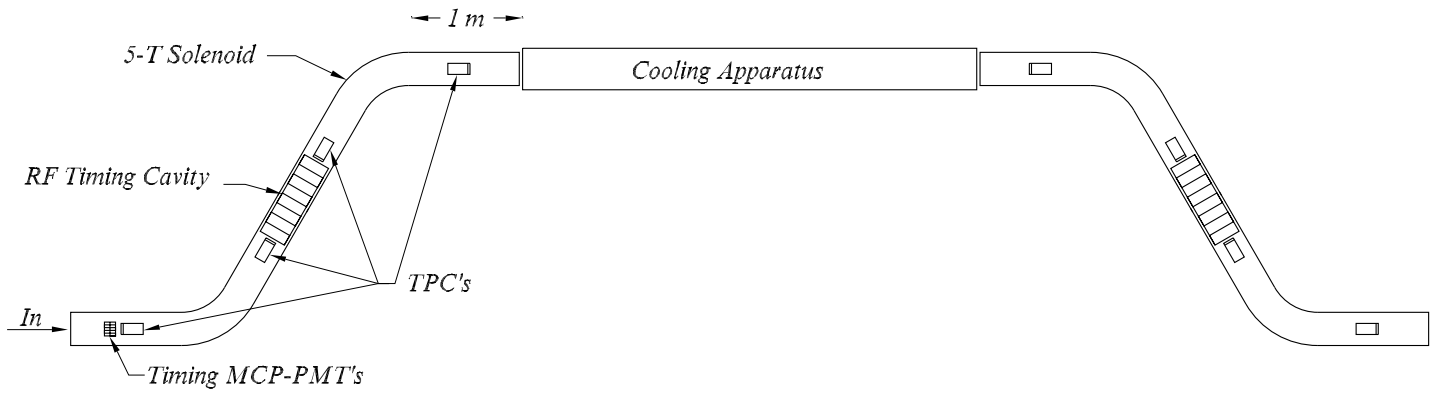

## Overview

**Measure muons individually**, and form a virtual bunch in software:

⇒ Must know timing to  $\approx 10$  psec to select muons properly phased to the 800-MHz RF of the cooling apparatus.

⇒ Use RF accelerating cavity to correlate time with momentum.

⇒ Must measure momentum 4 times.

[⇒ Must also have coarse timing ( $\lesssim 300$  psec) to remove phase ambiguity.]

**Large transverse emittance**,  $\epsilon_{N,x} = 1500\pi$  mm-mrad:

⇒ Confine the muon beam in a 5-Tesla solenoid channel.

⇒ All muon detection in the 5-T field.

⇒ Use bent solenoids (toroidal sectors) for momentum dispersion.

**Muon momentum = 165 MeV/c:**

⇒ Cyclotron period of 69 cm sets scale for detector arrangement.

⇒ Resolution limited by multiple scattering.

⇒ Perform tracking in a low-pressure gas.

5-T magnetic field ⇒ detector **E** field should be parallel to **B**.

⇒ **Time Projection Chambers** (TPC's)

## Time Projection Chamber

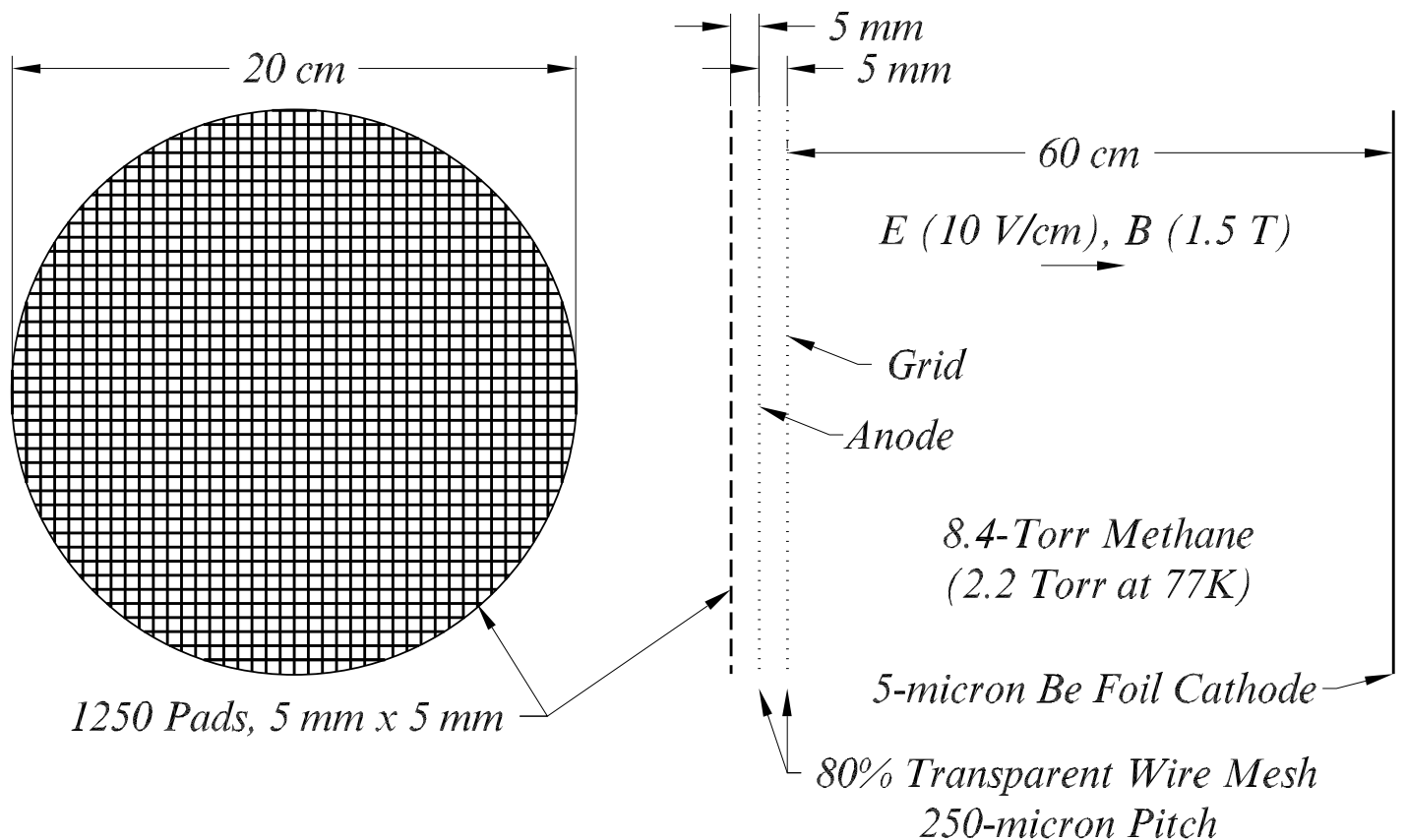

- Two TPC's in same pressure vessel for each of 4 momentum spectrometers.
- Low gas pressure  $\Rightarrow$  low operating voltage.
- 1250 cathode pads, 25-MHz timing sampling during 10  $\mu$ sec livetime.
- Analog pipeline via switched-capacitor arrays.
- Low mass  $\Rightarrow$  20-cm drift = 5  $\mu$ sec drift  $\Rightarrow$  only  $\approx$  1 MHz rate

capability.

## Cost Estimate

- Bent solenoid channel ..... \$2M
- Two 800-MHz RF timing cavities ..... \$0.5-1M
- 8 TPC's, 10,000 channels, \$100/channel ..... \$1M
- Auxiliary timing detector based on MCP-PMT's ..... \$0.3M
- **Total** ..... **\$2.5-4M**

Not considered:  $\pi$ - $\mu$ - $e$  identification.

# Detector Requirements

Must measure the distribution of the beam muons on all 6 axes of 6-D phase space:  $x, x', y, y', P$  and  $z$  or  $t$ .

$$\sigma_i = \text{rms width.}$$

Uncertainty in  $\sigma_i \equiv \delta_{\sigma_i}$ .

$$\epsilon = \prod_{i=1}^6 \sigma_i, \quad \text{so} \quad \frac{\delta_\epsilon}{\epsilon} = \sqrt{\sum_{i=1}^6 \left(\frac{\delta_{\sigma_i}}{\sigma_i}\right)^2} \approx \sqrt{6} \frac{\delta_\sigma}{\sigma}.$$

$$\text{Proposed goal:} \quad \frac{\delta_\sigma}{\sigma} = 0.01, \quad \text{so} \quad \frac{\delta_\epsilon}{\epsilon} = 0.03.$$



## Effect of Detector Resolution

$\sigma_D$  = detector resolution (in parameter  $i$ ).

$\delta_{\sigma_D}$  = uncertainty in detector resolution.

$\sigma_O$  = observed rms width,  $\sigma_O^2 = \sigma_i^2 + \sigma_D^2$ .

$$\Rightarrow \sigma_i^2 = \sigma_O^2 - \sigma_D^2.$$

$$\delta_{\sigma_i^2}^2 = \delta_{\sigma_O^2}^2 + \delta_{\sigma_D^2}^2.$$

$$\delta_{\sigma_O^2} = \sqrt{\frac{2}{N}} \sigma_O^2 = \sqrt{\frac{2}{N}} (\sigma_i^2 + \sigma_D^2).$$

$$\left(\frac{\delta_{\sigma_i}}{\sigma_i}\right)^2 = \frac{1}{2N} \left(1 + \frac{\sigma_D^2}{\sigma_i^2}\right)^2 + \left(\frac{\sigma_D}{\sigma_i}\right)^4 \left(\frac{\delta_{\sigma_D}}{\sigma_D}\right)^2.$$

## Perfectly Known Resolution

$$\delta_{\sigma_D} = 0 \Rightarrow \frac{\delta_{\sigma_i}}{\sigma_i} = \sqrt{\frac{1}{2N}} \left( 1 + \frac{\sigma_D^2}{\sigma_i^2} \right).$$

$$\text{If } \sigma_D > \sigma_i, \quad \text{then} \quad N \propto \left( \frac{\sigma_D}{\sigma_i} \right)^4.$$

$$\text{If } \sigma_D < \sigma_i, \quad \text{then} \quad \frac{\delta_{\sigma_i}}{\sigma_i} \approx \sqrt{\frac{1}{2N}}.$$

$\Rightarrow$  Require  $\sigma_D < \sigma_i$ .

## Large-N Limit

$$\frac{\delta_{\sigma_i}}{\sigma_i} = \left(\frac{\sigma_D}{\sigma_i}\right)^2 \frac{\delta_{\sigma_D}}{\sigma_D} = \frac{\sigma_D}{\sigma_i} \frac{\delta_{\sigma_D}}{\sigma_i}.$$

Good results can only be obtained if  $\sigma_D/\sigma_i$  is less than one.

If this ratio is much less than one very good results are possible.

## Maximum Acceptable Detector Resolution

$$\text{Suppose } \frac{\delta_{\sigma_D}}{\sigma_D} < 0.2.$$

$$\text{Then } \sigma_D < \sqrt{\frac{\delta_{\sigma_i}/\sigma_i}{\delta_{\sigma_D}/\sigma_D}} \sigma_i = 0.19\sigma_i.$$

$$\text{If } \frac{\delta_{\sigma_D}}{\sigma_D} < 0.01, \quad \text{then we can have } \sigma_D \approx \sigma_i \quad \text{and} \quad \frac{\delta_{\sigma_i}}{\sigma_i} = 0.01.$$

Phase-space parameters of the FOFO-channel cooling experiment.

Table 1:

Parameter	Input Value	Output Value
$P$ (MeV/ $c$ )	165	165
$E$ (MeV)	198	198
$\gamma$	1.85	1.85
$\beta$	0.84	0.84
$\gamma\beta$	1.56	1.56
$\epsilon_{x,N} = \epsilon_{y,N}$ ( $\pi$ mm-mrad)	1500	750
$\epsilon_x = \epsilon_y$ ( $\pi$ mm-mrad)	800	400
$\beta^*$ (cm)	10	14
$\sigma_x = \sigma_y$ (mm)	9	9
$\sigma_{x'} = \sigma_{y'}$ (mrad)	90	45
$\sigma_P/P$	0.03	0.04
$\sigma_E/E = \beta^2\sigma_P/P$	0.021	0.028
$\sigma_t$ (cm)	1	1.2
$\sigma_t = \sigma_z/\beta c$ (ps)	40	48

Required detector resolution to achieve measurement accuracy of 1% on the rms widths  $\sigma_i$ , assuming the detector resolution function is known to 20%, *i.e.*,  $\delta_{\sigma_D}/\sigma_D = 0.2$ .

Table 2:

Parameter	Value
$\sigma_{x,D} = \sigma_{y,D}$	2 mm
$\sigma_{x',D} = \sigma_{y',D}$	8 mrad
$\sigma_{P,D}/P$	0.006
$[\Rightarrow \sigma_{x',D}$	6 mrad]
$\sigma_{z,D}$	2 mm
$\sigma_{t,D}$	8 ps

The required detector resolution  $\sigma_D$  varies as the reciprocal of the square root of the uncertainty  $\delta_{\sigma_D}$  in the resolution.

The requirement on the momentum resolution  $\sigma_{P,D}/\sigma_P$  leads to a second requirement on the angular resolution  $\sigma_{x',D}$ .

## Extrapolating Along the Beam

Must know all 6 rms width,  $\sigma_i$ , at same place to calculate the emittance.

⇒ Extrapolation of time measurement by at least 50 cm.

⇒ Extrapolation by  $\approx 3$  m if want to know emittance at entrance to cooling apparatus.

$$\delta t = \frac{L}{\beta^2 c} \delta\beta = \frac{L}{\gamma^2 \beta c} \frac{\delta P}{P} \approx 1000 \text{ [ps]} \left[ \frac{L}{1 \text{ m}} \right] \frac{\delta P}{P}.$$

$$\frac{\sigma_P}{P} = 0.006 \quad \Rightarrow \quad \delta t = 6 \text{ ps/m}.$$

## Determination of Detector Resolution

Must determine the detector resolutions,  $\sigma_{i,D}$ , and their uncertainties,  $\delta_{\sigma_{i,D}}$  in preliminary studies.

For this, leave out cooling apparatus and join the ‘before’ and ‘after’ detector arms.

## TM<sub>0,1,0</sub> RF Timing Cavity

Studies of the TE<sub>0,1,1</sub> and TM<sub>2,1,0</sub> deflection cavities show a very marginal effect.

Consider a cylindrical TM<sub>0,1,0</sub> cavity of radius  $a$ , length  $b$  and peak field  $E_0 = 40$  MV/m for  $\omega = 2\pi 800$  MHz.

Phase the cavity so central particle gains no energy.

Then the (small) energy gain is a linear function of time within the bunch.

Fields:

$$\begin{aligned} E_r &= E_\phi = 0, \\ E_z &= E_0 J_0 \left( \frac{2.405r}{a} \right) \sin \omega t, \\ B_\phi &= E_0 J_1 \left( \frac{2.405r}{a} \right) \cos \omega t, \\ B_r &= B_z = 0. \end{aligned} \tag{1}$$

Dispersion relation:

$$\frac{\omega}{c} = \frac{2.405}{a}, \quad \text{so} \quad d = 2a = \frac{2.405}{\pi} \lambda = 0.766 \lambda = 28.725 \text{ cm.}$$



## Energy Gain:

$$\begin{aligned}
 \Delta U &= e \int E_z dz = e\beta_z c \int_{t_{\min}}^{t_{\max}} E_z dt \\
 &= e\beta_z c E_0 \int_{t_{\min}}^{t_{\max}} J_0 \left( \frac{2.405r}{a} \right) \sin \omega t dt \\
 &\approx e\beta_z c E_0 \int_{t_{\min}}^{t_{\max}} \sin \omega t dt = \frac{\beta_z c e E_0}{\omega} (\cos \omega t_{\min} - \cos \omega t_{\max}) \\
 &\approx -\frac{\beta_z c e E_0}{\omega} \frac{2\omega z_0}{\beta_z c} \sin \frac{\omega b}{2\beta_z c} = -2 \sin \frac{\omega b}{2\beta_z c} e E_0 z_0 \\
 &= -2e E_0 \sin \frac{\omega b}{2\beta_z c} \beta_z c \Delta t,
 \end{aligned}$$

$U \Delta U = c^2 P \Delta P \Rightarrow$  **Relative momentum change:**

$$\begin{aligned}
 \frac{\Delta P}{P} &= \frac{2e E_0 \beta_z c \Delta t}{\beta c P} \sin \frac{\omega b}{2\beta_z c} \\
 &= \frac{2 \cdot 40 \text{ [Mv/m]} \cdot 3 \times 10^{-4} \text{ [m/ps]} \cdot \Delta t \text{ [ps]}}{165 \text{ [MeV/c]} \cdot c} = 0.00014 \left[ \frac{\Delta t}{1 \text{ ps}} \right],
 \end{aligned}$$

using  $b = \lambda \beta_z / 3 = 10.5 \text{ cm}$  and  $P = 165 \text{ MeV/c}$ .

## 8-Cell Cavity

Consider an 8-cell RF cavity of same design as for cooling FOFO.

We wish to resolve  $8 \text{ ps} = 0.2\sigma_t$ .

Then the momentum gain is  $\Delta P/P = 8 \cdot 8 \cdot 0.00014 = 0.009$ .

This is of same order as desired momentum resolution.

## Straggling

$$\begin{aligned}\sigma_{P,\text{straggling}} &\approx \frac{\gamma r_e m_e c^2}{\beta c} \sqrt{2\pi N_0 \frac{Z}{A} s \left(1 - \frac{\beta^2}{2}\right)} \\ &\approx 0.11 \text{ [MeV}/c] \sqrt{\left[\frac{s}{1 \text{ g/cm}^2}\right]},\end{aligned}$$

Require  $\sigma_{P,\text{straggling}} < \sigma_{P,D} = 0.006P = 1 \text{ MeV}/c$  for  $P = 165 \text{ MeV}/c$ .

$$\Rightarrow s < \left(\frac{\sigma_{P,D}}{0.11}\right)^2 = \left(\frac{1}{0.11}\right)^2 = 80 \text{ [g/cm}^2\text{]}.$$

## Need for an Auxiliary Timing Measurement

Previous analysis holds only for  $t$  near zero.

In general, momentum kick varies as  $\sin(2\pi t/T)$ ,  $T = \text{RF period}$ .

$\Rightarrow$  Need auxiliary timing measurement with  $\delta t \lesssim T/4 = 300 \text{ ps}$ .

## Bent Solenoid Muon Channel

**Curvature Drift:** muon in bend sees transverse  $\mathbf{B}$  field  $\Rightarrow$  vertical displacement of 10 cm.

**Momentum Analyzing Power** still obeys

$$\frac{\Delta P}{P} \approx \frac{\Delta\theta}{\theta_b},$$

although  $\Delta\theta$  not always in bend plane.

We consider bend angle,  $\theta_b = 1$  radian.

Limit number of radiation lengths in momentum spectrometer:

$$X_0 < \left( \frac{\sigma_P}{P} \frac{P\beta}{14 \text{ MeV}/c} \right)^2 \approx 100 \left( \frac{\sigma_P}{P} \right)^2 \text{ radiation lengths.}$$

$$\sigma_P/P = 0.006 \Rightarrow X_0 < 0.0036.$$

**Cyclotron Frequency** for 165-MeV/ $c$  muons = 2.3 GHz,  
period = 2.73 ns = 69 cm.

Chose bent solenoids to contain exactly 1 cyclotron period.

Choose central straight solenoid to contain exactly 3 cyclotron periods (or 4 for extra length of RF timing cavity.

Place TPC's exactly one cyclotron period from ends of straight solenoids.

$\Rightarrow$  Each channel is  $2 + 1 + 3$  (or  $4$ )  $+ 1 + 2 = 9$  (or  $10$ ) cyclotron periods long = 6.2 (or 6.9) m.

# Momentum Resolution *vs.* Radius of Curvature

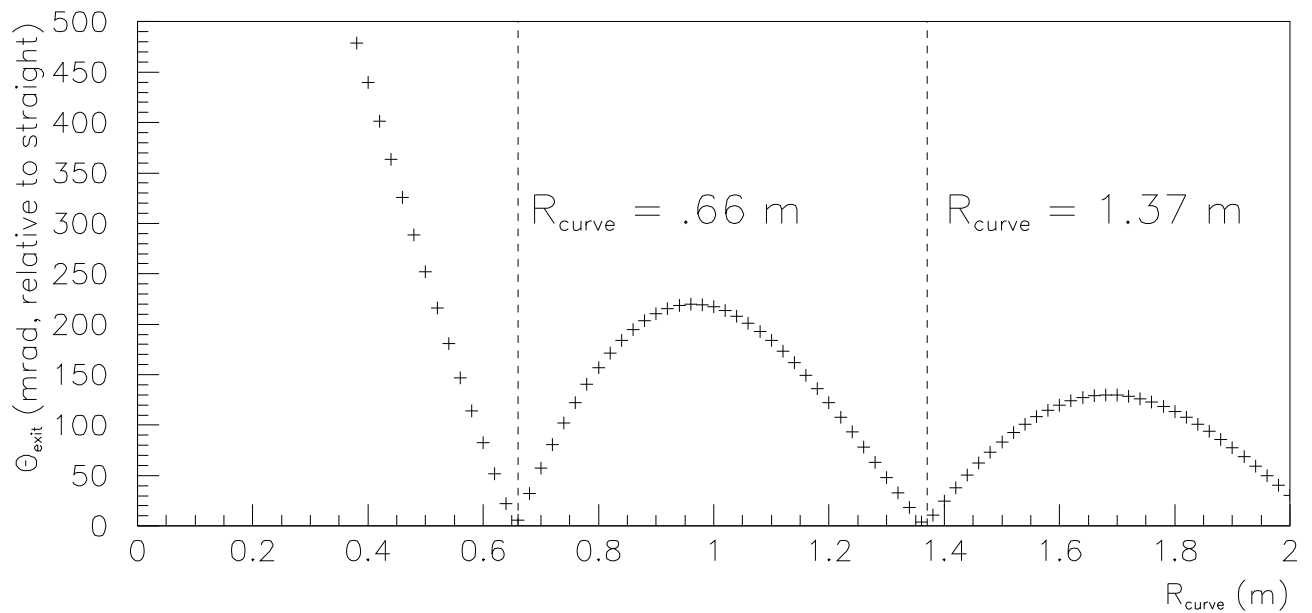
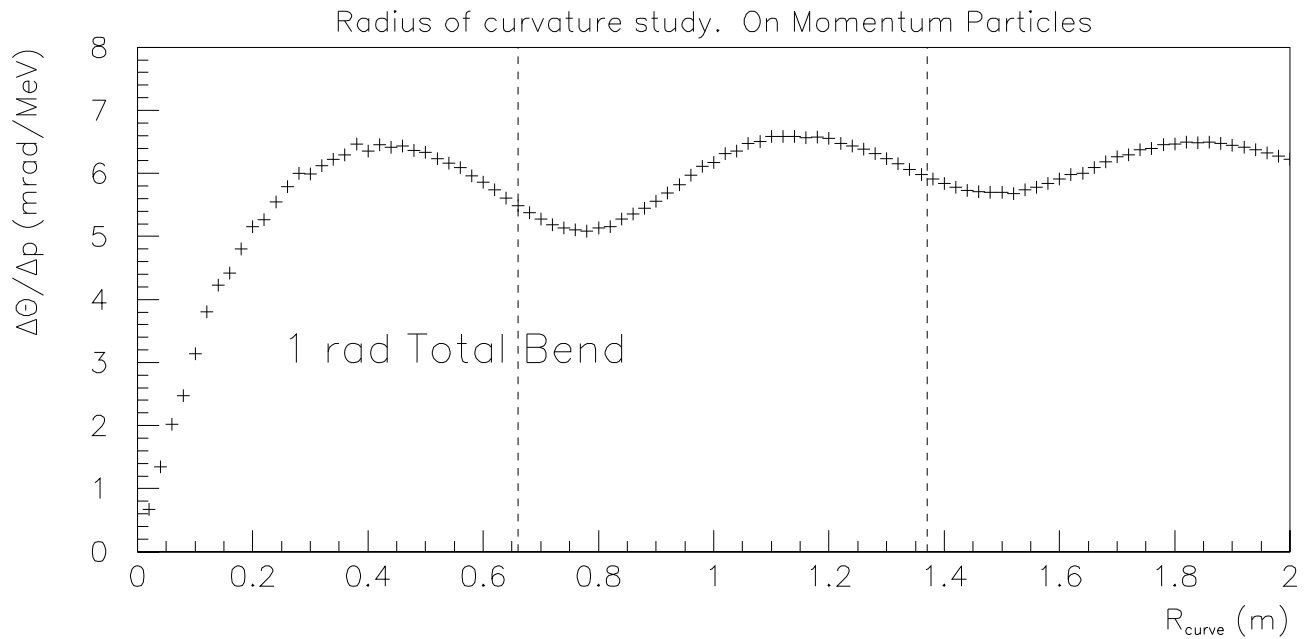

$\Rightarrow$  Only slight loss of resolution by choosing bent solenoid length = 1 cyclotron period.

Momentum resolution : 
$$\frac{\Delta P}{P} = 1.1\Delta\theta.$$

# Trajectory of the Central Muon

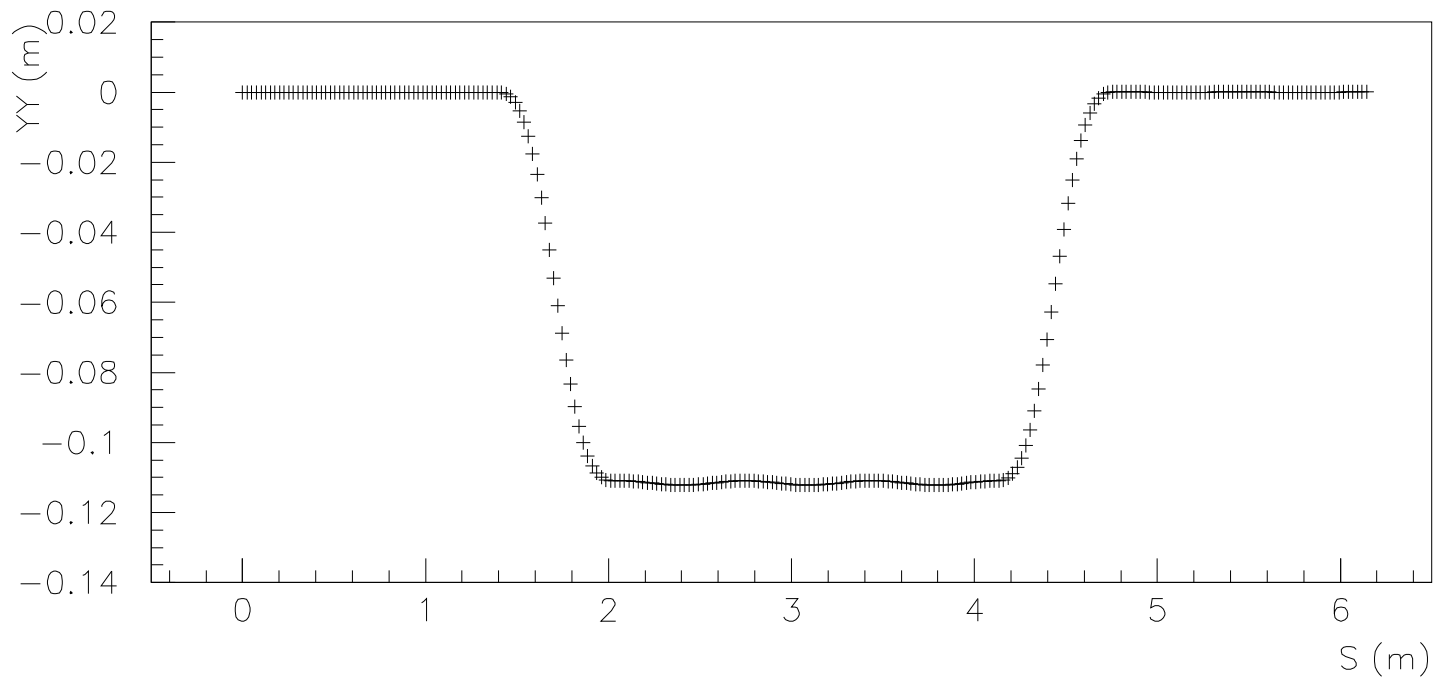
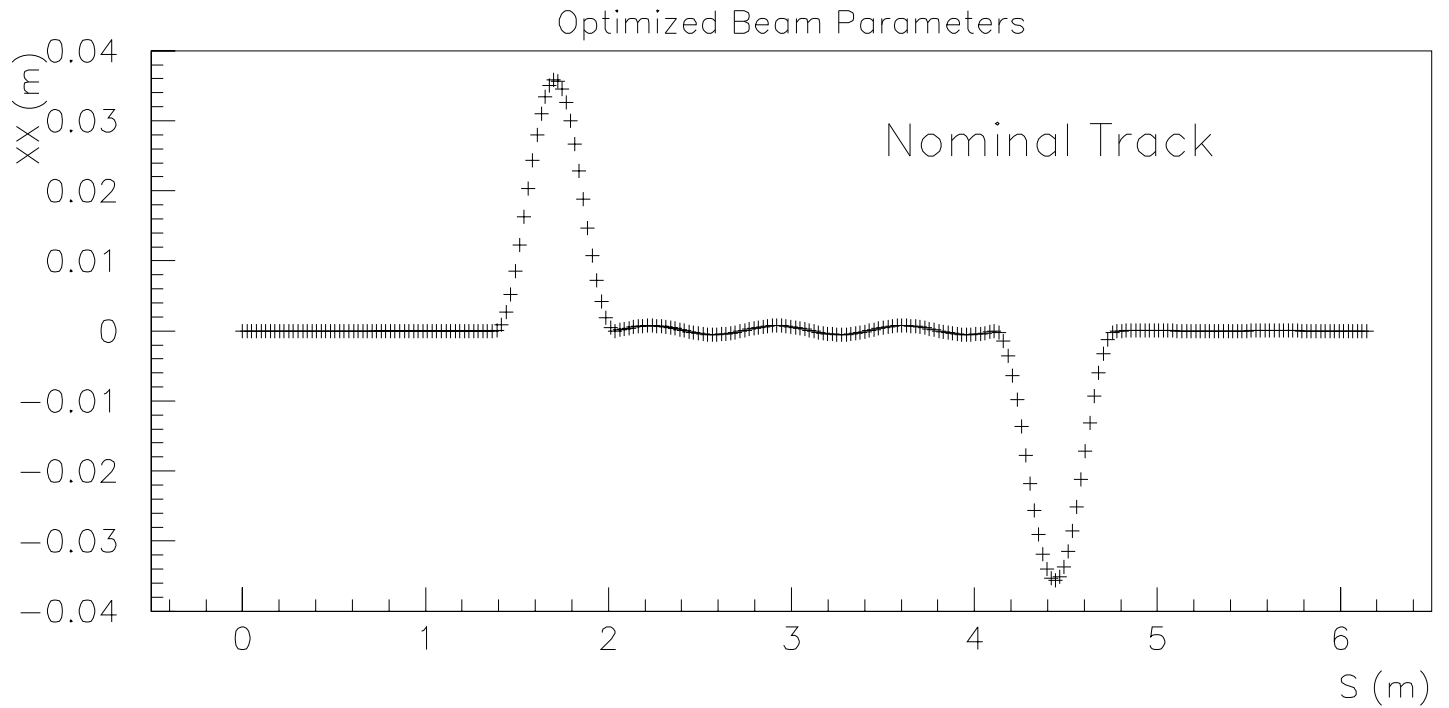

⇒ 11 cm vertical displacement due to curvature drift.

Cancelled by second bend.

# Trajectories of 50 Random Muons from Desired Bunch

Optimized Beam Parameters

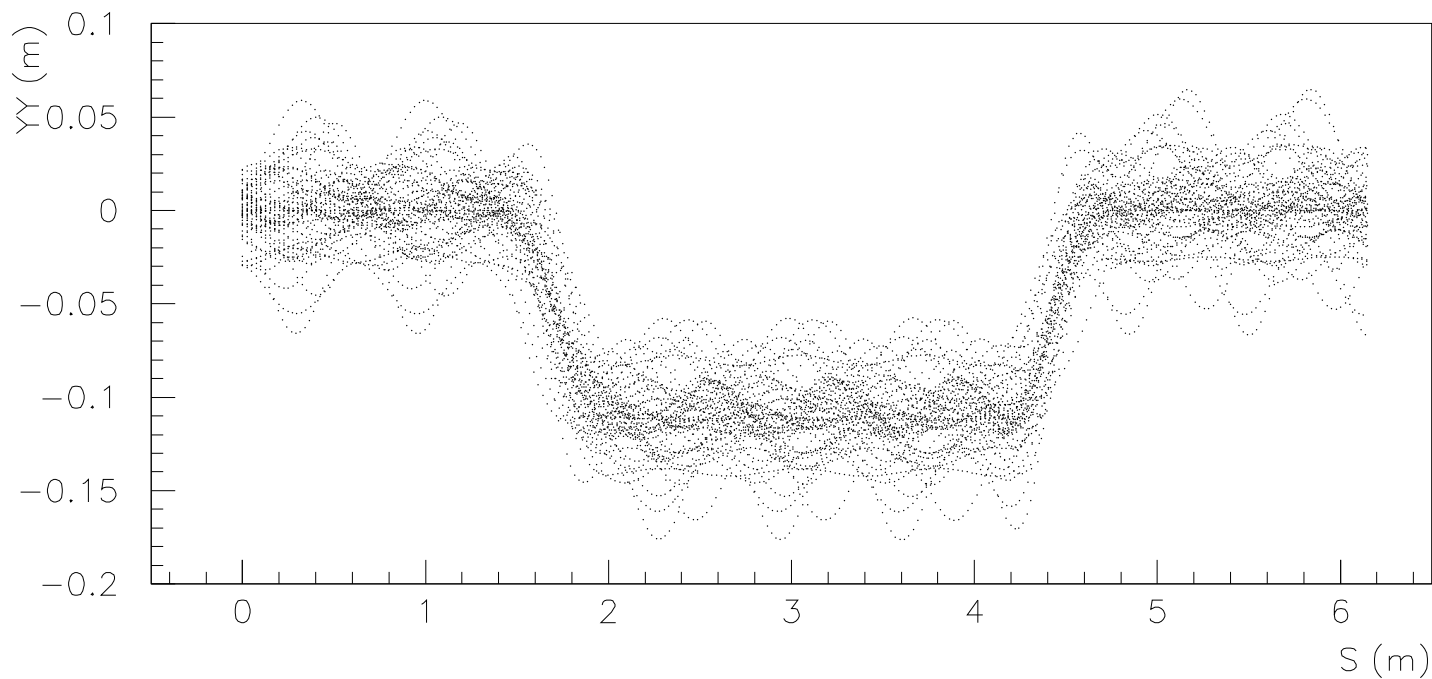
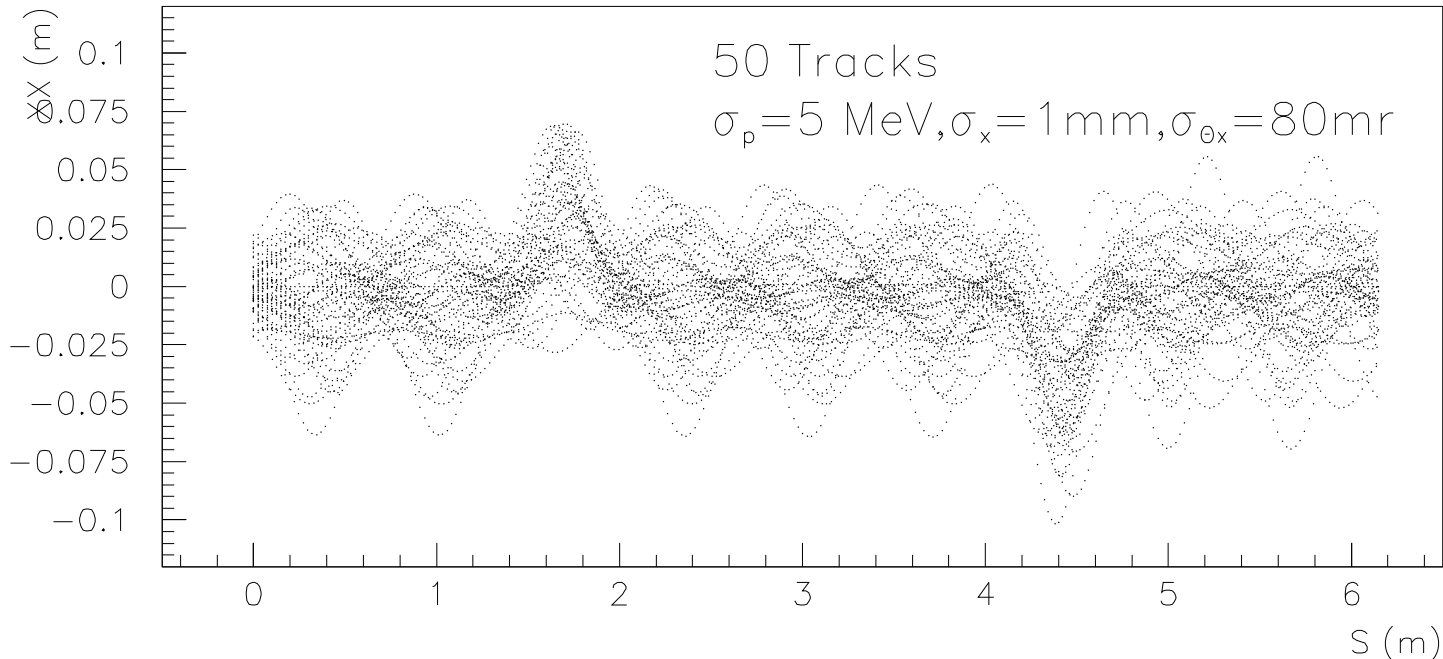



## Tracking in Low-Pressure Gaseous Detectors

$\sigma_P/P = 0.006$  at  $165 \text{ MeV}/c \Rightarrow X_0 < 0.0036$  radiation lengths.

One meter of air has 0.0033 radiation lengths!

$\Rightarrow$  Use low-pressure gas tracking.

Because mean-free path is longer at low pressure, it is much easier to obtain gas gain.

Both Townsend coefficient and drift velocity scale as  $E/P$ .

[ $E$  = electric field,  $P$  = pressure.]

$\Rightarrow$  Low-pressure chambers are more ‘natural’ than atmospheric pressure chambers.

Pure Hydrocarbon gases preferred because of greater immunity to UV-photon feedback.

[Compare AR/isobutane 95/5 at 1 atm, with pure isobutane at 1/20 atm.]

# Properties of Gases at Low Pressure

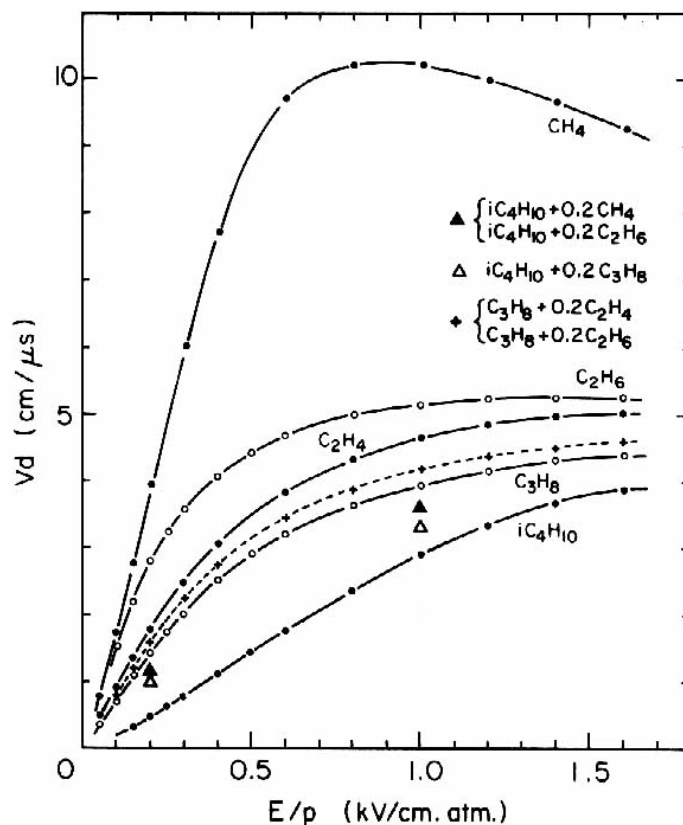

Fig. 185 Lehraus et al. (1982)

Parameter	Methane	Ethane	Isobutane
Atomic number	16	30	58
Boiling temp. ( $^{\circ}$ C)	-162	-88	-10
Primary clusters/cm at 1 atm.	30	49	100
Pressure (Torr)	25	16	7.6
Primary clusters/cm	1	1	1
Radiation lengths/m	0.0005	0.0006	0.0006
Saturation $E$ field (V/cm)	27	27	20
Saturation drift velocity ( $\mu$ m/ns)	100	50	40
Drift time over 20 cm ( $\mu$ sec)	2.0	4.0	5.0

# Time Projection Chamber

In 5-T magnetic field, **E** should be parallel to **B**.

Low-mass chamber  $\Rightarrow$  Minimize walls  $\Rightarrow$  **Single drift region**.

1 cluster/cm  $\Rightarrow$  Need  $\approx$  **20 cm path length** for good tracking.

$\Rightarrow$  Use small **Time Projection Chamber** (TPC).

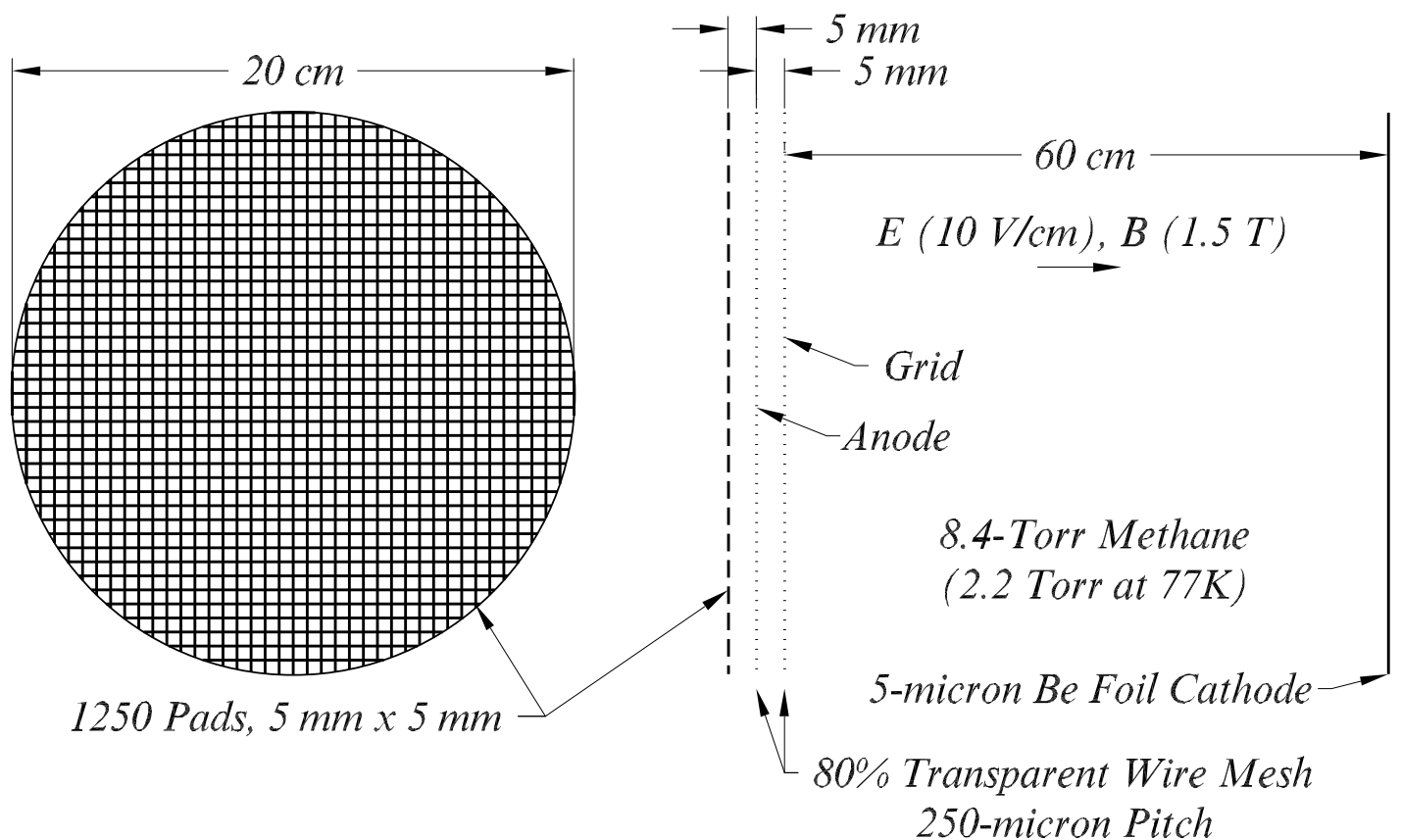

2 TPC's per momentum spectrometer  $\times$  4 spectrometers

⇒ Total of 8 TPC's.

# Use Multistep Chamber If Need Gain $> 10^6$

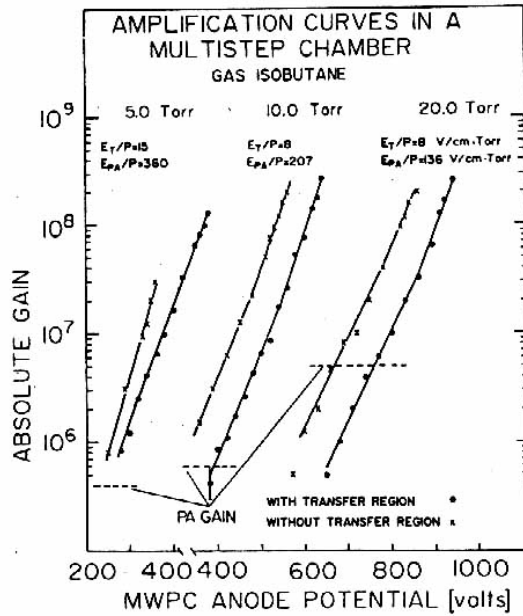
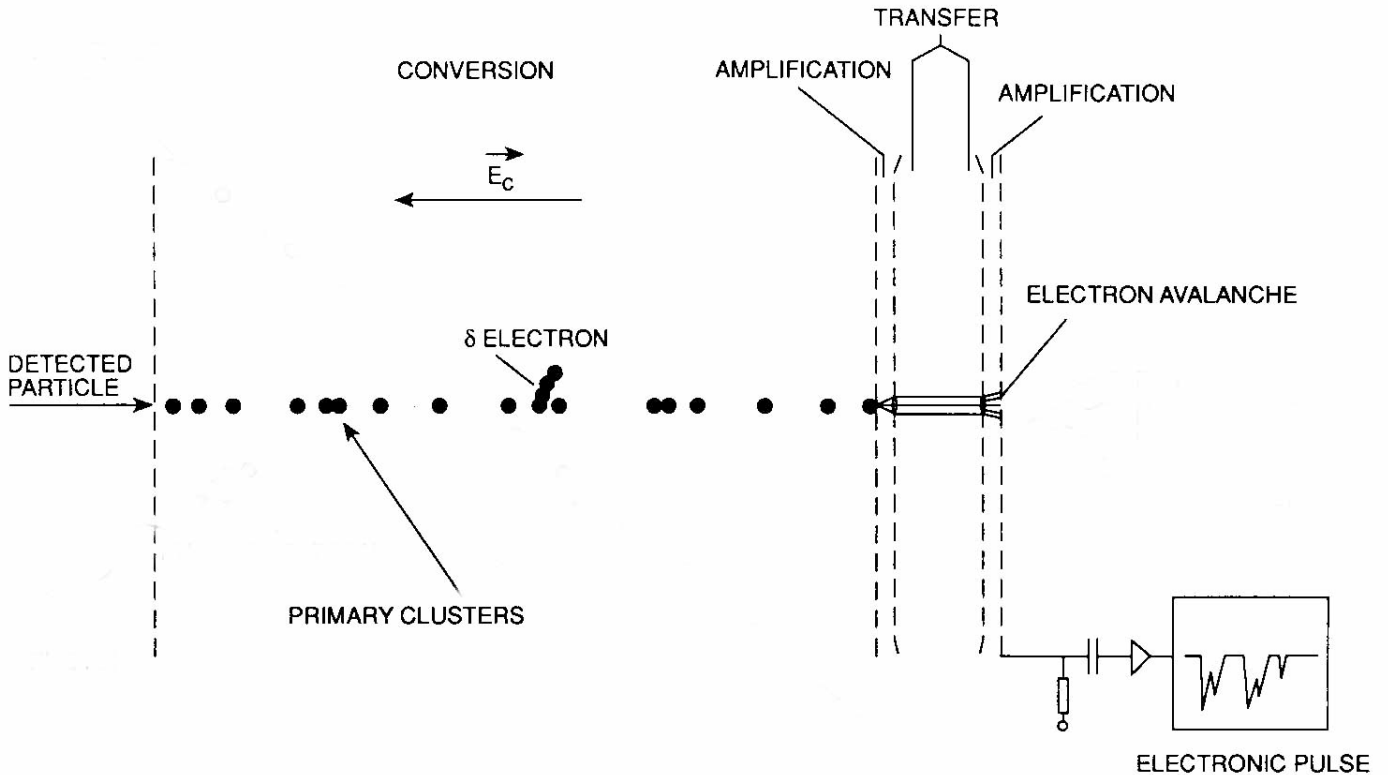

Fig. 2. Amplification curves for a MSC operated with isobutane at pressures of 5, 10 and 20 Torr. The absolute total gain of the MSCs is presented versus the anode potential of the MWPC, for constant values of the preamplification and transfer fields. The amplification factor of the first PPAC stage is represented by dashed lines.



## Cathode Pad Readout

Need to measure  $x$ ,  $y$  and  $z$  of clusters to reconstruct track.

$\Rightarrow$  Read out signals induced on pads on cathode plane.

Ex: 1250 pads/TPC,  $R_{\max} = 4$  cm  $\Rightarrow$  Pad size =  $2 \times 2$  mm<sup>2</sup>.

Goal:  $\sigma_x = \sigma_y = 200$   $\mu$ m = 1/10 pad width.

$\Rightarrow$  Charge-sharing readout must have noise  $< 1/10$  average signal.

Readout noise  $\approx 2 \times 10^4$  electrons  $\Rightarrow$  Gas gain =  $2 \times 10^5$ .

Angular resolution would then be  $200$   $\mu$ m/20 cm = 0.001

$\approx$  Same as multiple scattering limit.

# Time Sampling

Also want  $\sigma_z = 200 \mu\text{m} \Rightarrow \sigma_t = 5 \text{ ns}$  if use **isobutane**.

$\Rightarrow$  Must sample cathode pads every few  $\times 5 \text{ ns}$ .

Cluster separation = 1 cm,

$\Rightarrow$  Average time between clusters = 250 ns,

$\Rightarrow$  Must sample several times during 250 ns.

Choose 25 MHz sampling frequency (40 ns/sample).

Detector livetime/beam pulse  $\approx 10 \mu\text{sec} \Rightarrow 250 \text{ samples/pulse}$ .

These requirements are well matched to use of an analog pipeline based on switched capacitor arrays (SCA's):

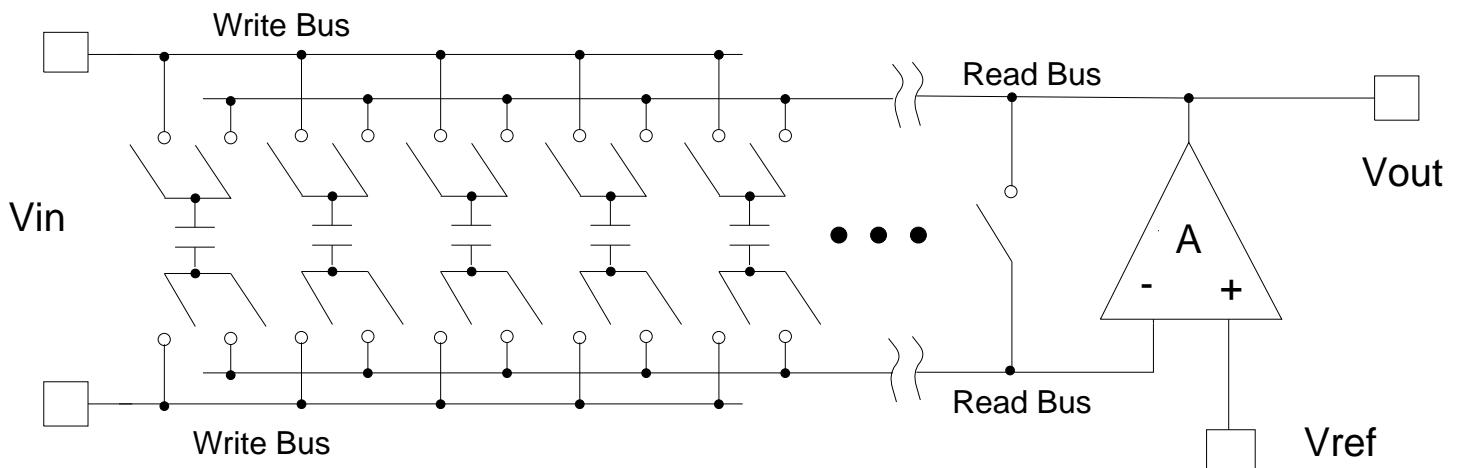

Candidate chip: 16-channel, 256-deep SCA by S. Kleinfelder (LBL).

# SCA Performance

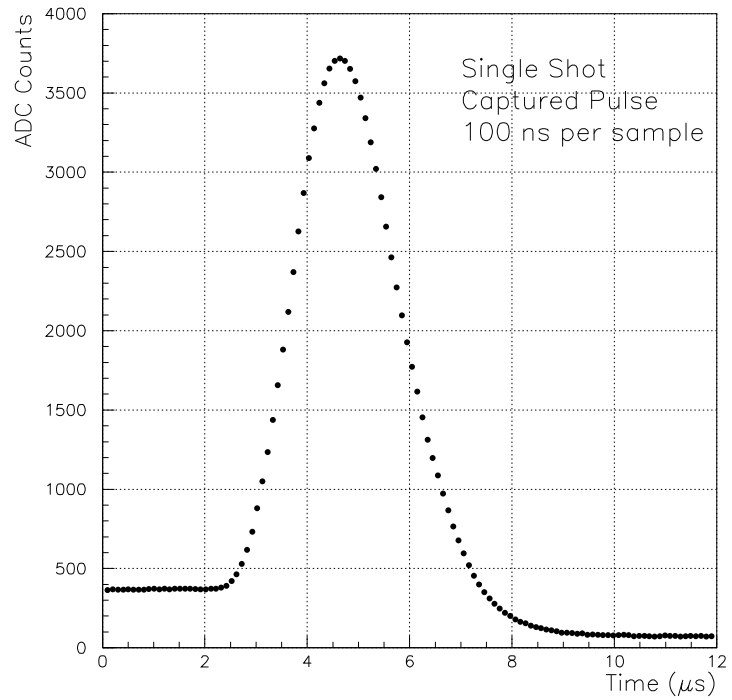

Dynamic range of 12 bits:

Time interpolation to 1/100 of sampling period:

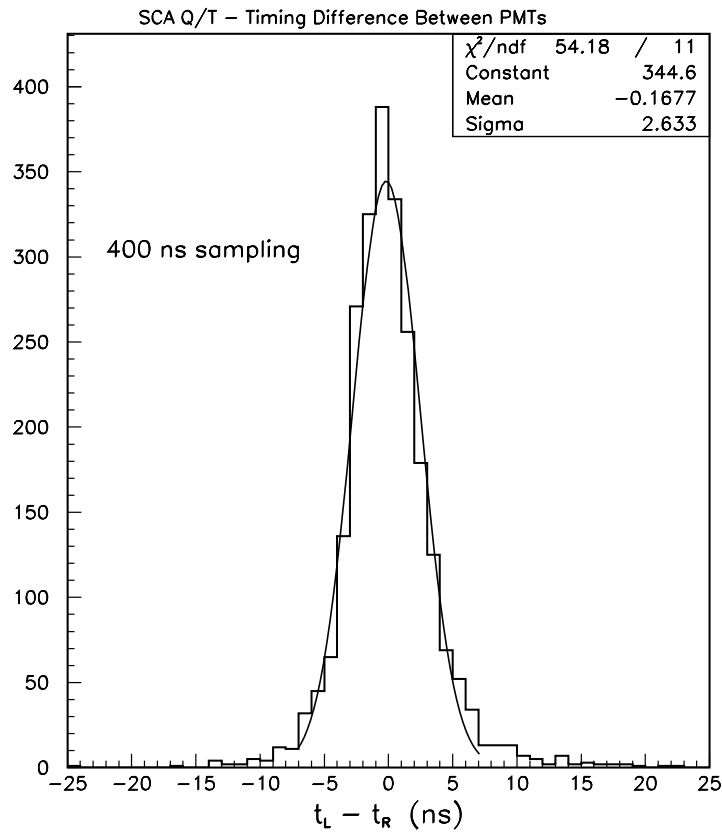



## Packaging

Place 80 16-channel preamps and SCA's around circumference of cathode pad plane inside pressure vessel.

ADC's and buffer memory outside pressure vessel.

## Rate Capability

Each TPC has  $1250 \ x\text{-}y \times 250 \ t$  samples = 300,000 'pixels'.

Each muon track has 20 clusters.

Each cluster occupies  $\approx 3^3 = 27$  pixels.

$\Rightarrow$  500 pixels/track.

Hence 600 muons/pulse  $\Rightarrow$  100% occupancy.

Good muon separation  $\Rightarrow \lesssim$  **10 muons/pulse** (1 MHz).

Then data rate  $\approx$  5,000 samples/pulse

= 75,000 samples/sec @ 15 Hz.

# Auxiliary Timing Detector

RF timing measurement requires auxiliary timing measurement with  $\sigma_t < 300$  ps to resolve ambiguity.

If auxiliary timing detector must reside in 5-T field, consider use of microchannel-plate photomultipliers (MCP-PMT's).

Hamamatsu R3809U: photocathode diameter = 11 mm

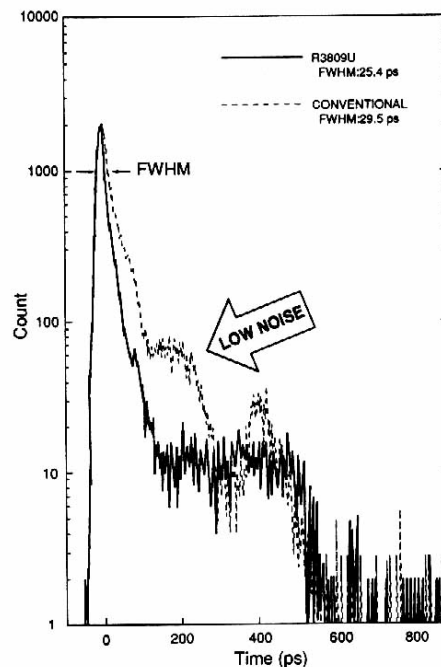
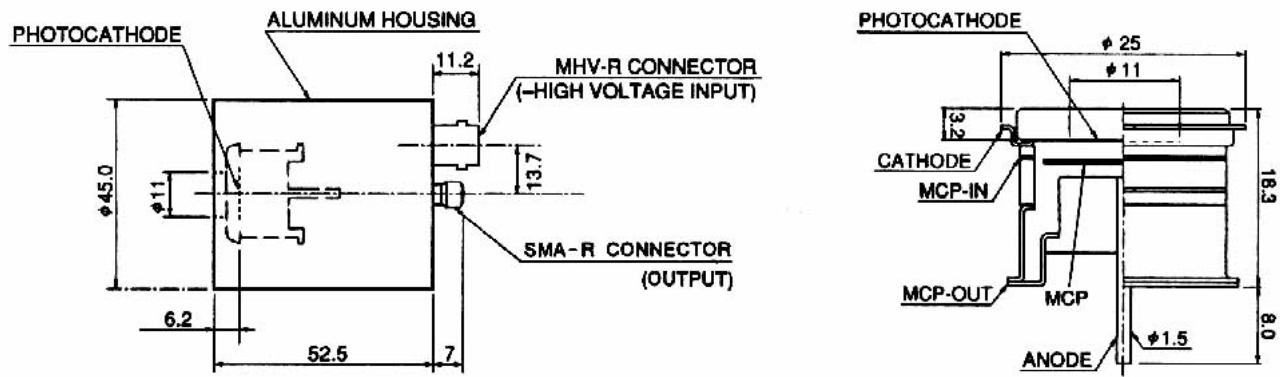

$\sigma_t = 12$  ps in device itself:

# Test of MCP-PMT Timing with Čerenkov Light

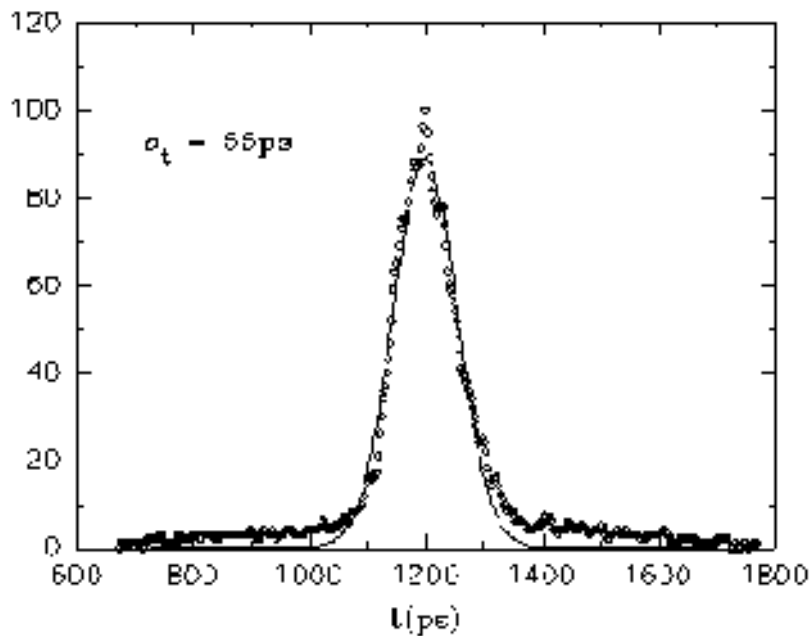
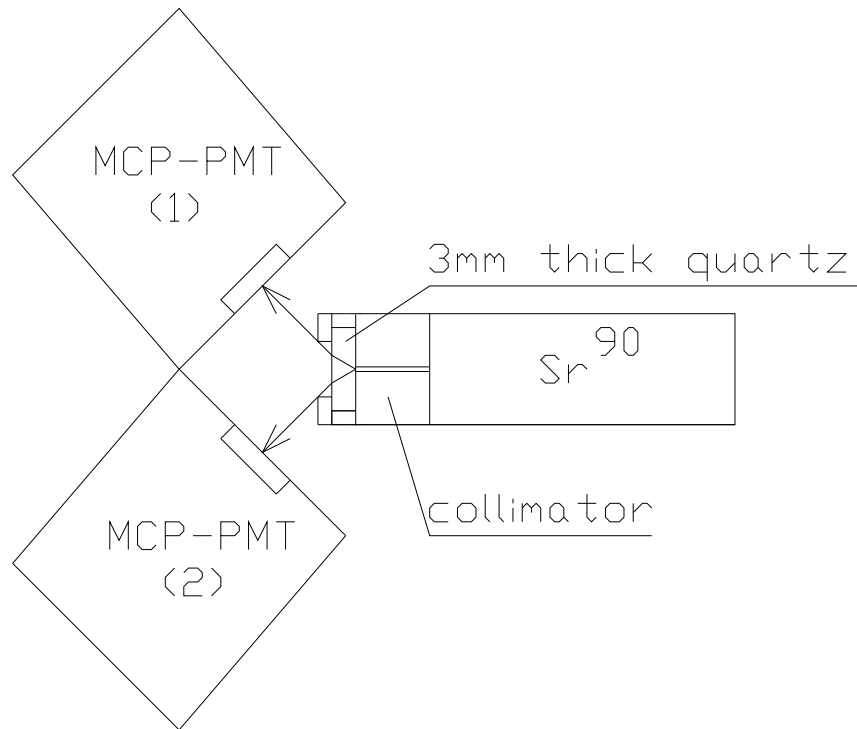

Observed  $\sigma_t = 55/\sqrt{2} = 39 \text{ ps}$  per device;

May have been limited by constant-fraction discriminator.

# Auxiliary Timing Device Using MCP-PMT's Viewing Čerenkov Light from Quartz Bars

